

## TC-0010 series

CODE	Operating Force (gf)
V	130±30
Z	250±100

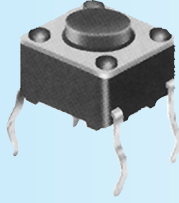
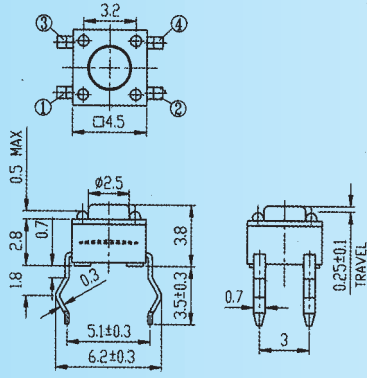

1. RATING: DC 12V 50mA
2. TRAVEL: 0.25 ± 0.1 mm
3. CONTACT RESISTANCE 100mΩ MAX
4. STEM LENGTH 3.8 mm

CIRCUIT DIAGRAM

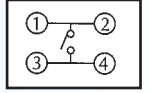

## TC-0020 soft touch

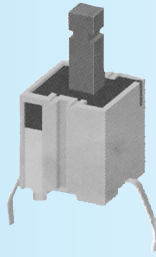
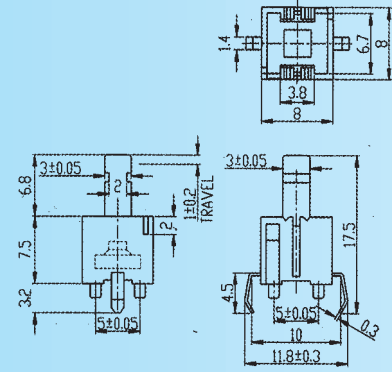

1. RATING: DC 12V 50mA
2. TRAVEL: 1.0 ± 0.2 mm
3. CONTACT RESISTANCE 100mΩ MAX
4. OPERATING FORCE: 130±30gf

CIRCUIT DIAGRAM

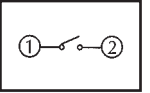

## TC-0102 series

MODEL	Stem length, mm	CODE	Operating Force, gf
TC-0102	4.3	T	100±30
TC-0103	5	V	130±30
TC-0104	7	X	160±50
TC-0105	7.3	W	170±50
TC-0106	8	Y	190±50
TC-0107	8.5	Z	250±100
TC-0108	9.5	N	350±100
TC-0109	12.5		
TC-A109	13.0		
TC-0110	13.5		
TC-0111	17		

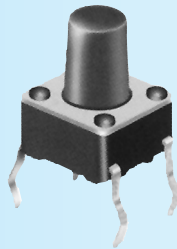
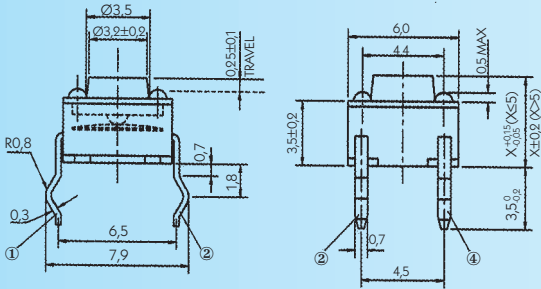

1. RATING: DC 12V 50mA
2. TRAVEL: 0.25 ± 0.1 mm
3. CONTACT RESISTANCE 100mΩ MAX

CIRCUIT DIAGRAM

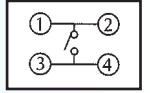

## TC-0112 series

MODEL	Stem length, mm	CODE	Operating Force, gf
TC-0112	4.3	T	100±30
TC-0113	5	V	130±30
TC-0114	7	X	160±50
TC-0115	7.3	W	170±50
TC-0116	8	Y	190±50
TC-0117	8.5	Z	250±100
TC-0118	9.5		
TC-0119	12.5		

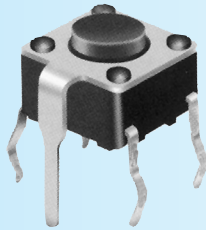
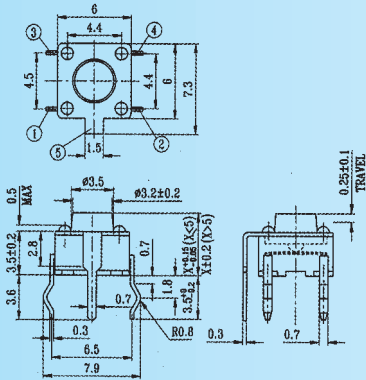

1. RATING: DC 12V 50mA
2. TRAVEL: 0.25 ± 0.1 mm
3. CONTACT RESISTANCE 100mΩ MAX

CIRCUIT DIAGRAM

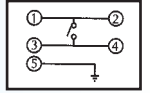

## TC-0120 series

MODEL	Stem length, mm	CODE	Operating Force, gf
TC-0120	4.3	Y	180±50
TC-0121	5	Z	250±100
TC-0122	8		

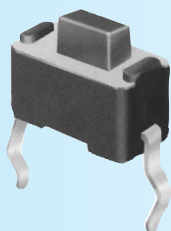
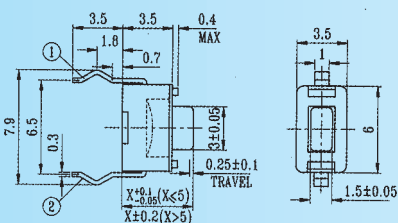

1. RATING: DC 12V 50mA
2. TRAVEL: 0.25 ± 0.1 mm
3. CONTACT RESISTANCE 100mΩ MAX

CIRCUIT DIAGRAM

