

PY-401 (SERIES, 2.5 mm)

Optional Accessory: AZ-005
Rating: 0.3A 30V DC

MODEL No.	FUNCTION	BUSHING	CONTACT FORM
PY-401-N	MONO	UN-THREATED	3
PY-401-C	MONO	THREATED	3

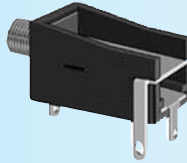
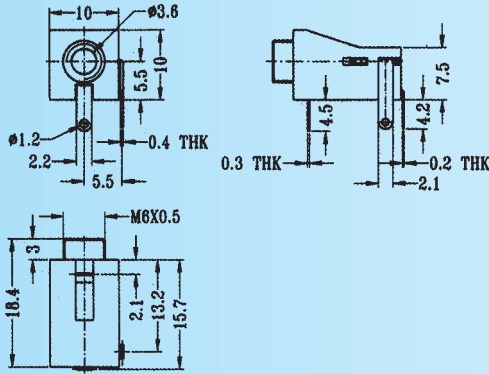

PY-601 (SERIES, 3.5 mm)

Optional Accessory: AZ-004
Rating: 0.3A 30V DC

MODEL No.	FUNCTION	BUSHING	CONTACT FORM
PY-601-C	MONO	THREAD	3
PY-601-N	MONO	UN-THREATED	3
PY-602-N	MONO	UN-THREATED	1

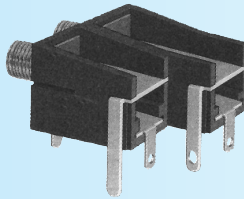
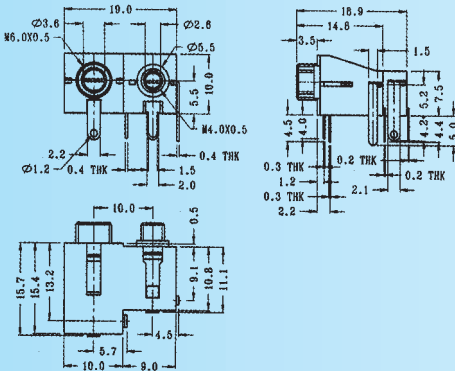

PY-601-401-C (SERIES, 3.5+2.5 mm)

Rating: 0.3A 30V DC

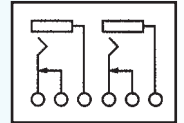

BUSHING	UN-THREATED
BUSHING COLOR	NICKEL
CONTACT FORM	3

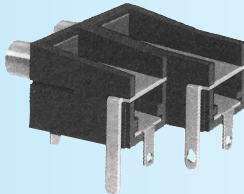
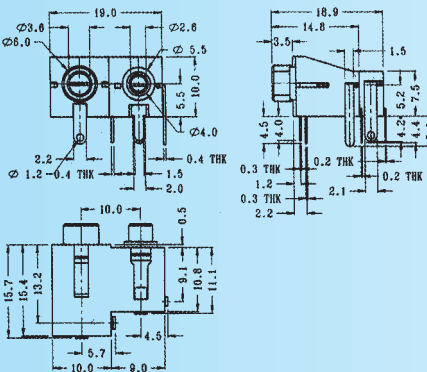

PY-601-401-N (SERIES, 3.5+2.5 mm)

Rating: 0.3A 30V DC

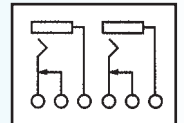

BUSHING	UN-THREATED
BUSHING COLOR	NICKEL
CONTACT FORM	3

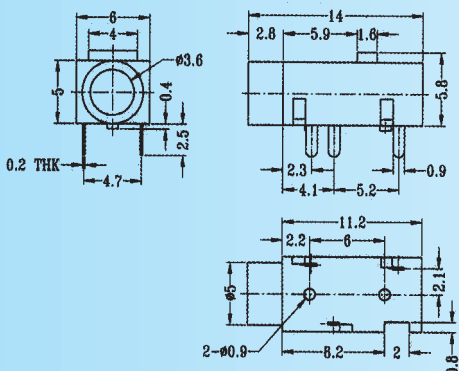

ST-001

Function: STEREO
Rating: 0.3A 30V DC
SMT TYPE OPTION YES

