

PS8C-5-B1R3-6H

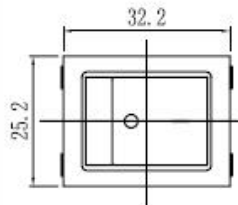

SWITCHING CIRCUIT

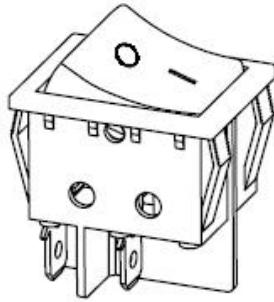
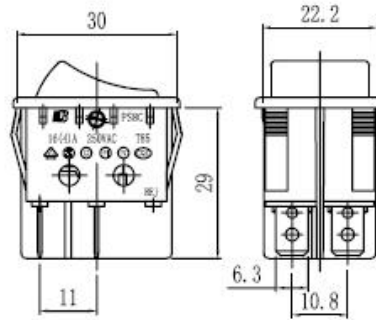
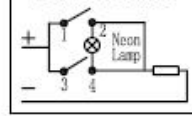

PANEL CUT-OUT

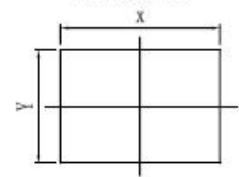

PANEL THICKNESS	DIM. X	DIM. Y
0.75~1.25	30.1/30.0	22.3/22.2
1.25~2.0	30.3/30.2	22.3/22.2
2.0~3.0	30.6/30.5	22.3/22.2

PS8C-5-B2R3-6H

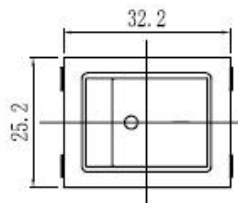
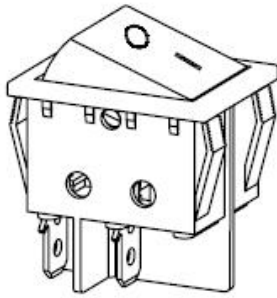

SWITCHING CIRCUIT

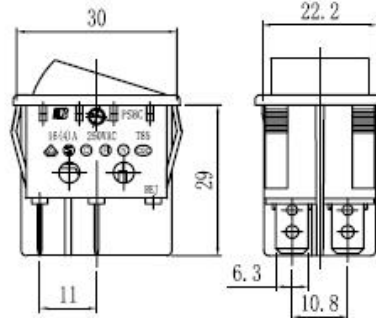
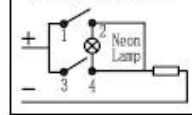

PANEL CUT-OUT

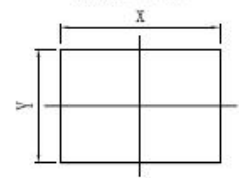

PANEL THICKNESS	DIM. X	DIM. Y
0.75~1.25	30.1/30.0	22.3/22.2
1.25~2.0	30.3/30.2	22.3/22.2
2.0~3.0	30.6/30.5	22.3/22.2

PS8C-6-B1B3-1H

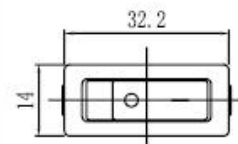
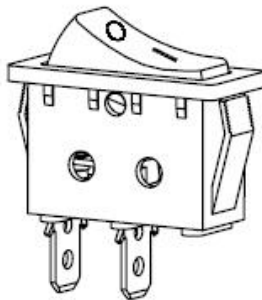

SWITCHING CIRCUIT

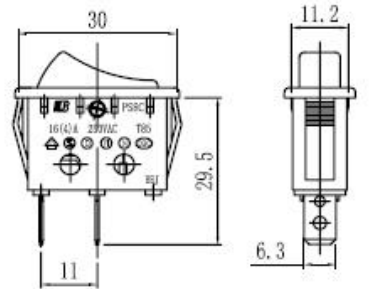
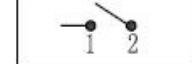

PANEL CUT-OUT

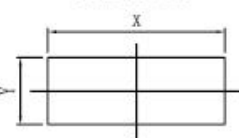

PANEL THICKNESS	DIM. X	DIM. Y
0.75~1.25	30.1/30.0	11.3/11.2
1.25~2.0	30.3/30.2	11.3/11.2
2.0~3.0	30.6/30.5	11.3/11.2

PS8C-6-B1R3-2H

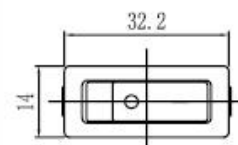
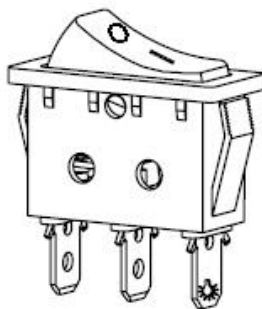

SWITCHING CIRCUIT

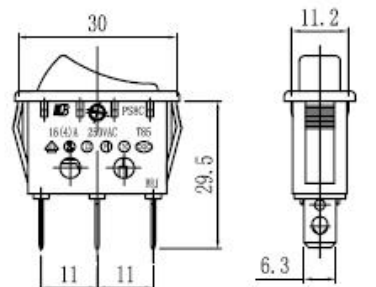
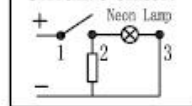

PANEL CUT-OUT

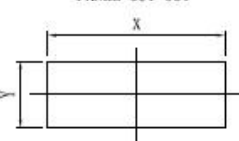

PANEL THICKNESS	DIM. X	DIM. Y
0.75~1.25	30.1/30.0	11.3/11.2
1.25~2.0	30.3/30.2	11.3/11.2
2.0~3.0	30.6/30.5	11.3/11.2

PS8C-6-B2R3-2S

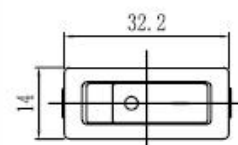

SWITCHING CIRCUIT

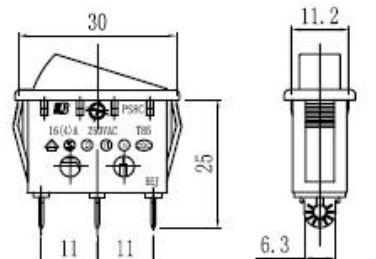
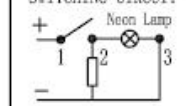

PANEL CUT-OUT

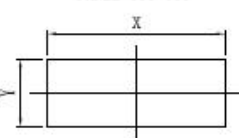

PANEL THICKNESS	DIM. X	DIM. Y
0.75~1.25	30.1/30.0	11.3/11.2
1.25~2.0	30.3/30.2	11.3/11.2
2.0~3.0	30.6/30.5	11.3/11.2