

**SK-62H12 (L1 R3)**

Rating: 0.3A 50V DC  
Function: 6P2T

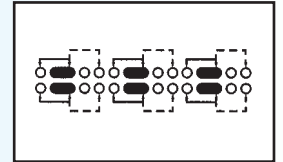

Optional Knob type

MX	GD				

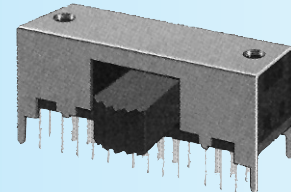
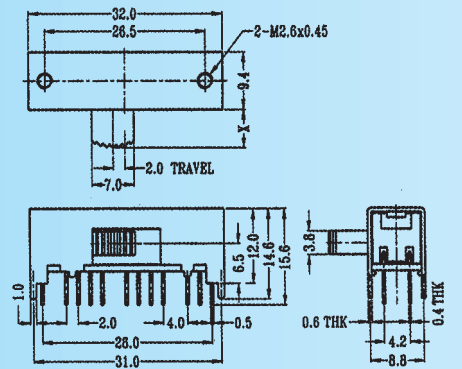

**SK-63D01 (L1 R3)**

Rating: 0.3A 50V DC  
Function: 6P3T

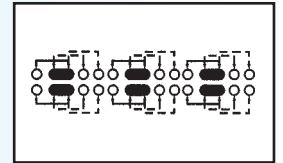

**S** SHORTING

Optional Knob type

MX	GD				

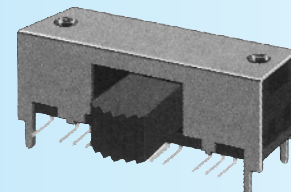
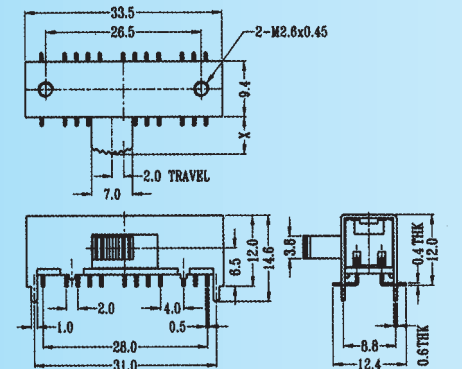

**SK-63D03 (L1 R3)**

Rating: 0.3A 50V DC  
Function: 6P3T

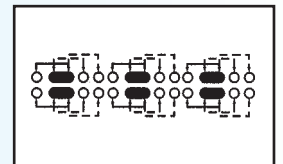

**S** SHORTING

Optional Knob type

MX	GD				

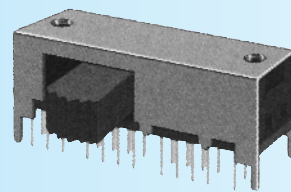
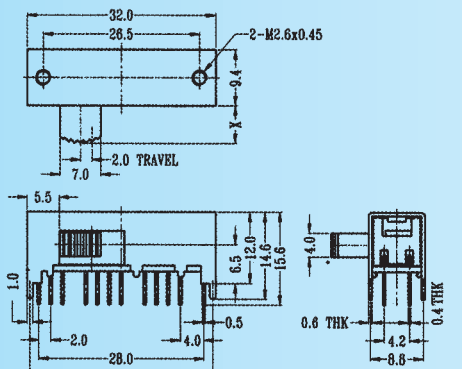

**SK-63D10 (L3 R1)**

Rating: 0.3A 50V DC  
Function: 6P3T

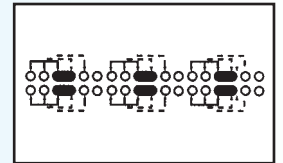

**S** SHORTING

Optional Knob type

MX	GD				

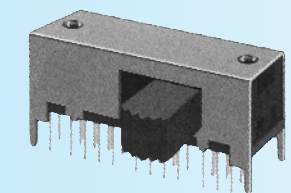
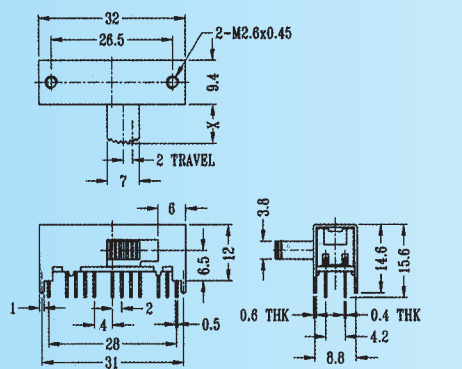

**SK-63D11 (L1 R3)**

Rating: 0.3A 50V DC  
Function: 6P3T

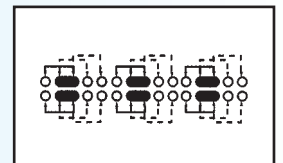

**S** SHORTING

Optional Knob type

MX	GD				