

PS-92D01 **N** NON-SHORTING

PS-92D03 **S** SHORTING

Rating: 0.3A 50V DC
Function: 9P2T

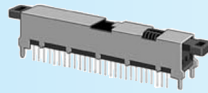
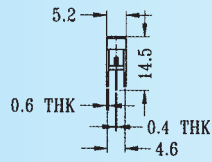
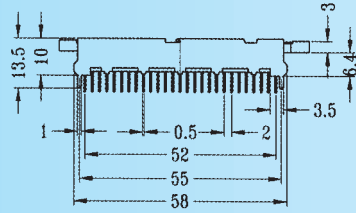
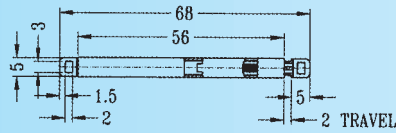
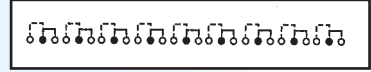

PS-92D04

Rating: 0.3A 50V DC
Function: 9P2T

S SHORTING

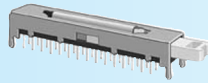
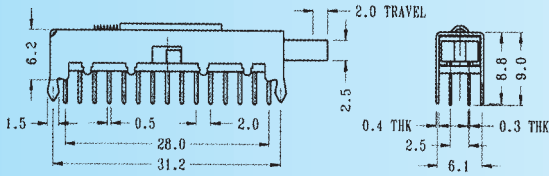
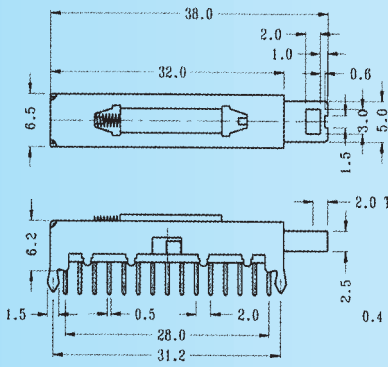

PS-102D02 **N** NON-SHORTING

PS-102D12 **S** SHORTING

Rating: 0.3A 50V DC
Function: 10P2T
(SPRING RETURN)

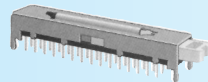
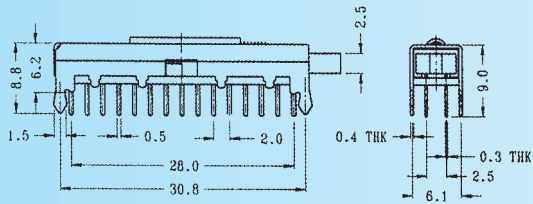
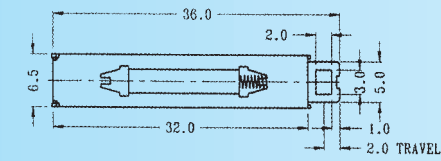
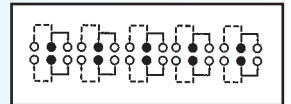

PS-102D03

Rating: 0.3A 50V DC
Function: 10P2T
(SPRING RETURN)

N NON-SHORTING

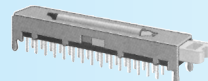
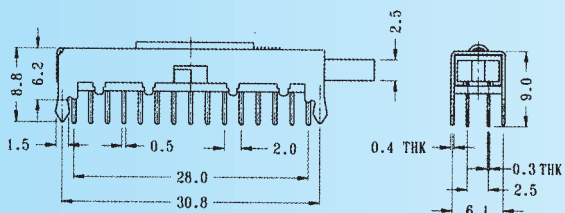
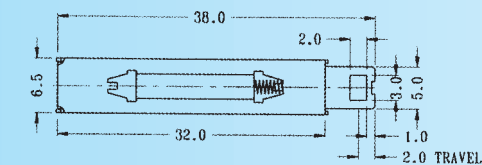
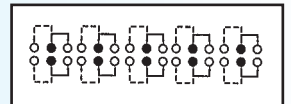

PS-102D05

Rating: 0.3A 50V DC
Function: 10P2T
(SPRING RETURN)

N NON-SHORTING

S SHORTING

